

## High Current Automobile Rectifier

**Reverse Voltage - 50 to 1000Volts**  
**Forward Current - 25 Amperes**

### Features

- Better heat dissipation
- Low power loss
- High surge forward current capability
- High temperature soldering guaranteed: 265°C/10S

### Mechanical Data

- Case: JEDEC ARS molded plastic
- Polarity: Color band denotes cathode

### Applications

- Generally applied in alternator, motorbike, automobile, etc.

ARS

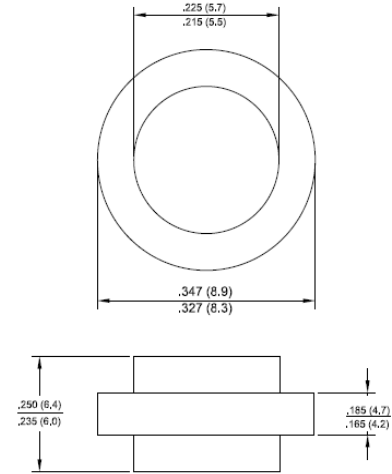

RoHS  
COMPLIANT

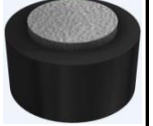

Package Outline Dimensions in Inches (Millimeters)

## Maximum Ratings and Electrical Characteristics

Rating at 25°C ambient temperature unless otherwise specified.

Single phase, half wave, 60Hz, resistive or inductive load.

For capacitive load, derate current by 20%.

Characteristics	Symbol	ARS25A	ARS25B	ARS25D	ARS25G	ARS25J	ARS25K	ARS25M	Unit
Maximum Repetitive Peak Reverse Voltage	V <sub>RRM</sub>	50	100	200	400	600	800	1000	V
Maximum RMS Voltage	V <sub>RMS</sub>	35	70	140	280	420	560	700	V
Maximum DC Blocking Voltage	V <sub>DC</sub>	50	100	200	400	600	800	1000	V
Maximum Average Forward Rectified Current @T <sub>A</sub> =55 °C	I(AV)	25							A
Peak Forward Surge Current, 8.3mS Single Half Sine-Wave, Superimposed on Rated Load (JEDEC Method)	I <sub>FSM</sub>	400							A
I <sup>2</sup> t Rating for Fusing (t<8.3mS)	I <sup>2</sup> t	664							A <sup>2</sup> S
Maximum Instantaneous Forward Voltage at Rated Forward Current	V <sub>F</sub>	1.1							V
Maximum DC Reverse Current at Rated @T <sub>J</sub> =25°C	I <sub>R</sub>	10							uA
DC Blocking Voltage @T <sub>J</sub> =150°C		1000							
Typical Junction Capacitance (Note1)	C <sub>J</sub>	300							pF
Typical Thermal Resistance Junction to Ambient	R <sub>θJA</sub>	1.0							°C/W
Operating Junction Temperature Range	T <sub>J</sub>	-55 to +150							°C
Storage Temperature Range	T <sub>STG</sub>	-55 to +150							°C
Position of polarity ring denotes cathode, while color denotes voltage gradation.		Red	Yellow	Orange	Silver	Green	Blue	Purple	

Notes: 1. Measured at 1.0 MHz and applied reverse voltage of 4.0V DC.

2. The typical data above is for reference only

Fig. 1 - Forward Current Derating Curve

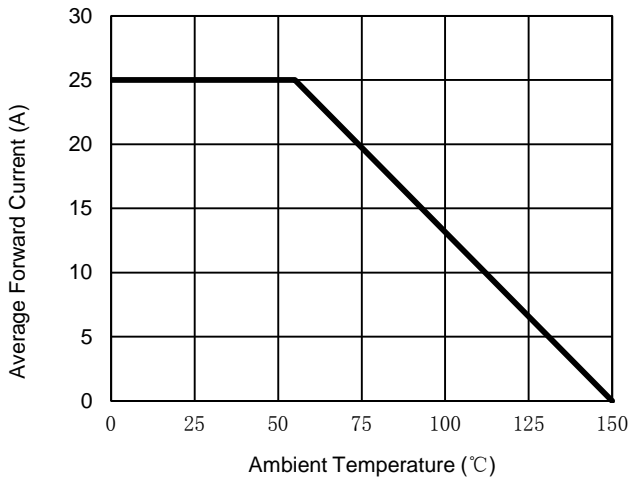

Fig. 2 - Maximum Non-Repetitive Surge Current

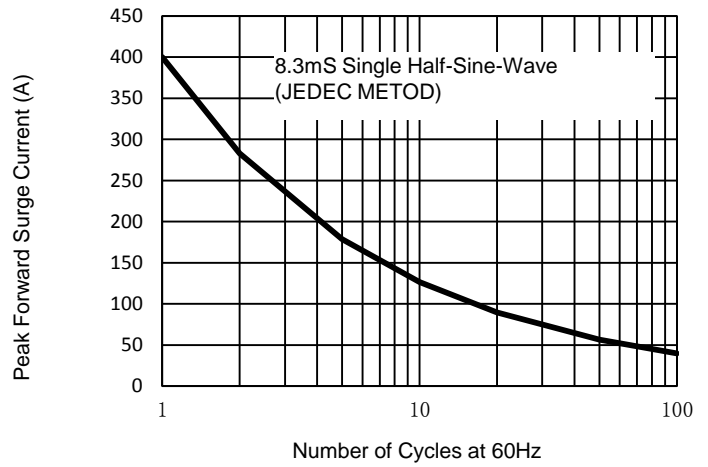

Fig. 3 - Typical Reverse Characteristics

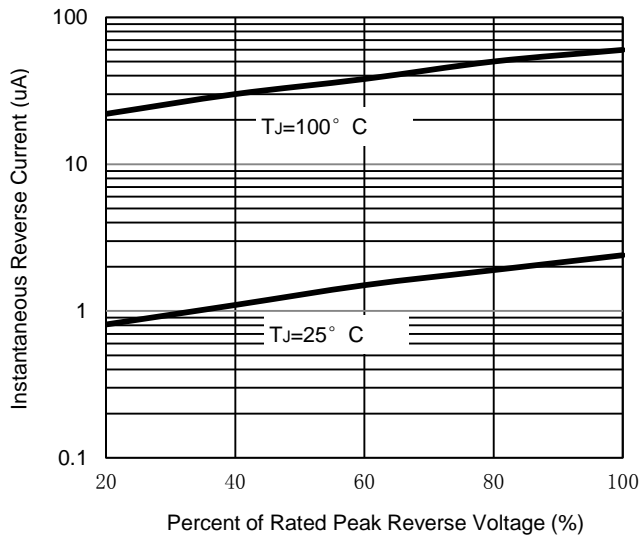

Fig. 4 - Typical Forward Characteristics

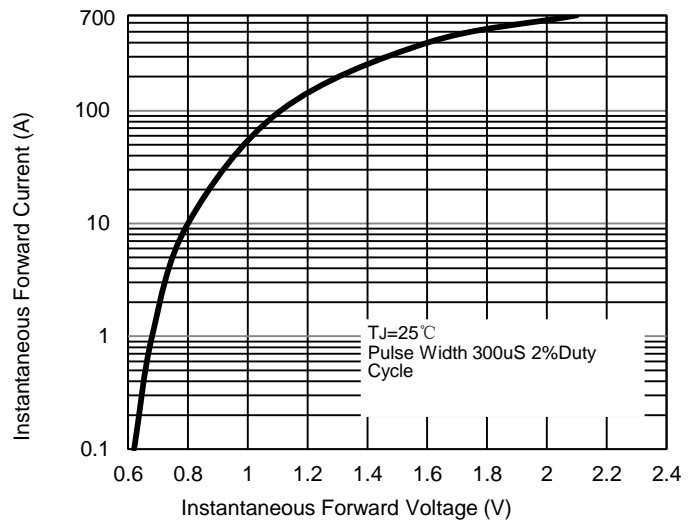
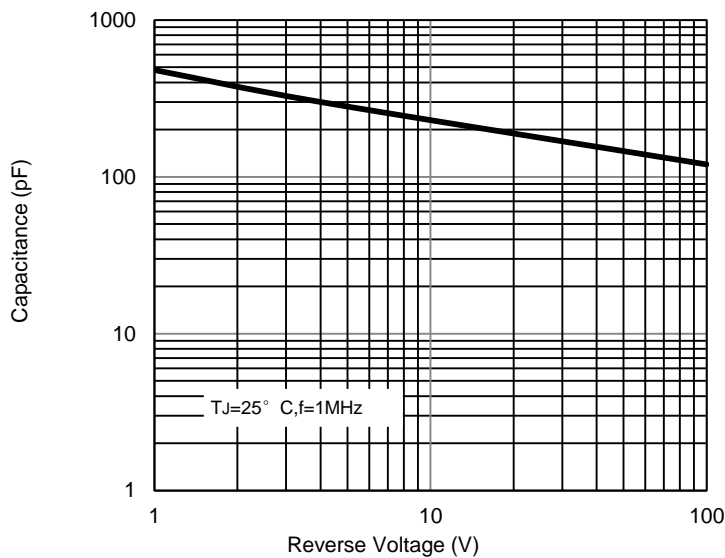

Fig. 5 - Typical Junction Capacitance



The curve above is for reference only.



## Disclaimer

ALL specifications and data are subject to be changed without notice to improve reliability function or design or other reasons.

HY makes no warranty, representation or guarantee regarding the suitability of the products for any particular purpose or the continuing production of any product. To the maximum extent permitted by applicable law, HY disclaims (i) any and all liability arising out of the application or use of any product, (ii) any and all liability, including without limitation special, consequential or incidental damages, and (iii) any and all implied warranties, including warranties of fitness for particular purpose, non-infringement and merchantability.

Statements regarding the suitability of products for certain types of applications are based on HY's knowledge of typical requirements that are often placed on HY products in generic applications. Such statements are not binding statements about the suitability of products for a particular application. It is the customer's responsibility to validate that a particular product with the properties described in the product specification is suitable for use in a particular application. Parameters provided in datasheets and specifications may vary in different applications and performance may vary over time. All operating parameters, including typical parameters, must be validated for each customer application by the customer's technical experts. Product specifications do not expand or otherwise modify HY's terms and conditions of purchase, including but not limited to the warranty expressed therein.

Except as expressly indicated in writing, HY products are not designed for use in medical, life-saving, or life-sustaining applications or for any other applications in which the failure of the HY product could result in personal injury or death. Customers using or selling HY products not expressly indicated for use in such applications do so at their own risk. Please contact authorized HY personnel to obtain written terms and conditions regarding products designed for such applications.

No license, express or implied, by estoppel or otherwise, to any intellectual property rights is granted by this document or by any conduct of HY. Product names and markings noted herein may be trademarks of their respective owners.

## 声明

所有的规格及数据如因改进可靠性、功能、设计或其他原因发生变更，恕不另行通知。

HY 对产品特定用途的适用性或任何产品的连续生产不做担保、陈述或保证。在可适用法律允许的最大程度上，HY 不承担 (i) 因应用或使用任何产品产生的任何及全部责任，(ii) 包括但不限于特定、连带或附带损害产生的任何及全部责任，(iii) 不做任何形式默认担保，包括不保证特定用途的使用性、非侵权及商业适销性。

关于产品适用于某类应用的声明以 HY 掌握的 HY 产品一般应用环境下的典型要求为准。此类声明与产品特定应用的适用性声明不存在任何关联。客户自行负责根据产品技术规格的说明认证特定产品是否适用于特定的应用。数据手册和技术规格中提供的参数可能因不同的应用而异，而且性能可能随时间而变化。所有工作参数，包括电型参数，必须有客户的技术专家根据每一个客户应用环境确认。产品技术规格不扩展或不以其他方式修改 HY 的采购条款与条件或不以其他方式修改 HY 的采购条款与条件，包括但不限于规定的质保条件。

除非书面注明，否则 HY 产品不用于医疗、救护或生命维护，或其他因 HY 产品发生故障有可能导致人身伤亡的应用场合。客户使用或销售未明确指示可在上诉应用中使用的 HY 产品风险自负。如欲获得有关指定用于上诉应用的产品的书面条款及条件，请与 HY 授权人员联系。

本档或任何 HY 的行为不以禁止反言或其他方式授予任何知识产权的许可，无论显示还是暗示。本文提到的产品名称和标识可能为各自所有者的商标。